

User's Manual 用户使用手册 Professional Power Amplifier

I-2x1200W



目录表

重要安全事项和符号说明.....	1
前言.....	2
前板功能介绍.....	3
后板功能介绍.....	4
产品连接说明.....	5
技术指标.....	6
故障排除.....	7
保修条例.....	8
产品物质拆分表.....	8







Table of contents

Important Safety Instruction and symbol description.....	9
Foreword.....	10
Front panel functions.....	11
Rear panel functions.....	12
System connection cases.....	13
Specifications.....	14
Troubleshooting.....	15
Warranty.....	16

重要安全事项

1. 阅读这些规定，注意所有警告，遵守这些规定。
2. 严禁在产品周围喷洒液体。请勿在产品上方放置液体容器，如花瓶等。可使用干布及风枪进行清洁。
3. 注意不要形成热风循环。按建议方法进行安装。
4. 不将产品安装在热源附近，尽可能保证环境气温在35°C以下。
5.  接地保护，当产品接通电源时，应采取相应的接地保护措施。
6. 请保护好电源线，防止其受到踩踏或挤压，尤其要注意插头、电源插座及其连接设备处。
 警告：电源插头/设备耦合器作为电路切断装置，应保持随时可用。
7. 必须按照以下开关次序来使用该产品：（开）前级-功放、（关）功放-前级。
8. 通电前必须确保供电电压符合该产品的要求。
9. 若输入信号并接超过三台功放，建议使用信号分配器，以确保输入信号不失真。
10. 不要将功放的某一个声道的输出接口接到另一个通道的输入接口。不要将功放的输出并联或串联到另一台功放的输出接口。
11. 设计系统配置功放的时候，功放的功率应比音箱在相同阻抗下的标称功率大50%-100%，且小心使用桥接模式。
12. 在维修功放的时候，禁止在桥接状态下将示波器的探头 连接到功放的输出端，以免损坏功放和示波器。
13. 建议：1) 由于输出到音箱的电流较大，建议使用符合标准的NL4型音箱螺旋插头。
2) 多台功放使用时应计算好合适的配电，以确保达到合格的使用环境。

安全说明

	输入/输出接驳线缆不可堆叠在产品排风扇口, 请置于功放两侧捆扎好!		本产品仅适用于海拔2000m以下安全使用。 (仅限于本公司的开关电源设备)
	非水平堆叠时，建议机尾排风口向上或直向排风口。		本产品仅适用于非热带气候条件下安全使用。
	工作环境气温应<35°C。		需经专业回收的物料，不能放置入垃圾桶。
	在工程调试时验证机柜内气温，在极限条件下，也应保持在35°C以下。		小心触电，非拥有相关资质的人员请勿擅自开盖维修。



警告 为避免着火或电击，不要将产品暴露在雨中或潮湿的环境中。

欢迎

非常感谢您购买蜚声演出器材制造有限公司产品。
本产品内置HD+HR技术，具有高解析力、大动态表现，声音通透顺滑、绵密有力、富有颗粒感，动态能量充沛，令整体音色更为密度更高，更加流畅，好唱不费力，又能给予超大的动态，引领新一代KTV的声音潮流！

开箱

请在拆开包装后，确认功放的外观没有在运输途中遭到损坏。确认功放的预设电压与使用地的交流电压额定值匹配（详细信息见功放背板印刷），建议您保留包装箱，以便在需要退还产品时使用

支持与服务

请直接联系蜚声演出器材制造有限公司在当地的分销商，以获得快速的售后服务和技术支持，如有技术问题需要直接与制造商联系，可以通过以下方式：

电子邮件：support@saechina.com

传真：+86-757-8568-8191

重要的安全注意事项

蜚声演出器材制造有限公司的产品在设计时已经考虑到安全使用的要求，并遵照相关的国家的安全规定检验出厂，只有合格的产品才能出厂销售。但由于本产品内部有危险高电压和电量，因此请用户在使用前必须认真阅读本手册的注意事项。如果产品跌落、凹入、浸湿或者机体内部有部件松动，将会大大增加人被电击的危险。当发生以上问题时，请马上切断电源，然后将本产品送还指定的经销商进行检查维修！

配线配电

参考不同型号产品的耗散功率与供电/AC进行配线
建议用户搭配不低于以下的配线径规格，以获得更佳的综合性能。

标配电压：220V~

型号	耗散功率	配线径规格
I-2x1200W	3000W	≥2.5mm ²

前面板

指示灯说明

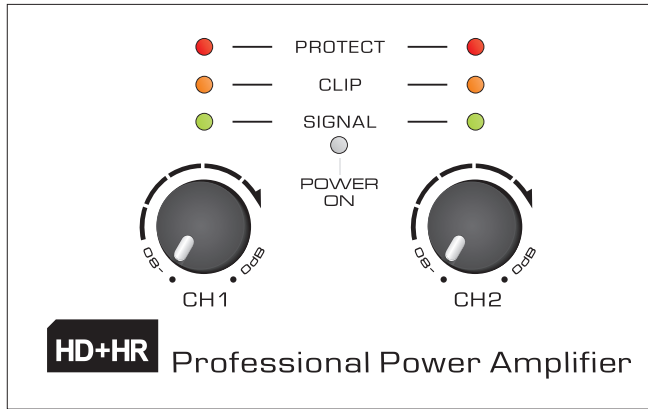

PROTECT → 任何一种保护电路动作时亮起

CLIP → 削峰电路动作时亮起

SIGNAL → 输出信号幅度约+6dB(2V)时亮起

POWER ON → 开机后亮起

CH1-CH2 → 增益控制器旋钮（调音量）
300°音量旋钮0/-80dB。
对于正常使用，将控制器保持在最大(0dB)。

滤尘网清洁操作指引



在工程建设完成时，应对滤网进行首次清洁。
在往后的时间，应根据实际的情况，建议每季度定期进行清洁一次。

不允许拆除该滤网继续使用本产品，否则将影响本机的使用寿命。

在此情况下产生的故障，将被认定为脱保！

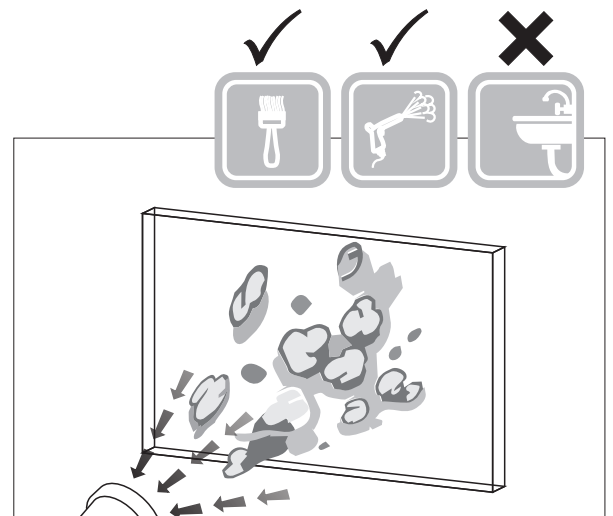

后面板

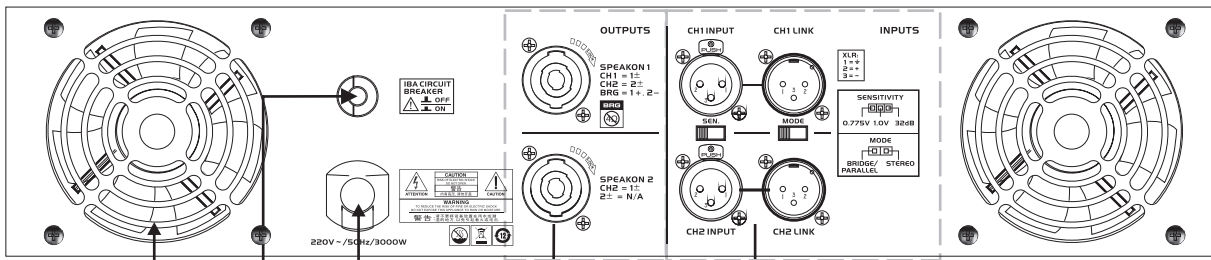

排风扇 断路器 电源线

功率输出端

信号连接端

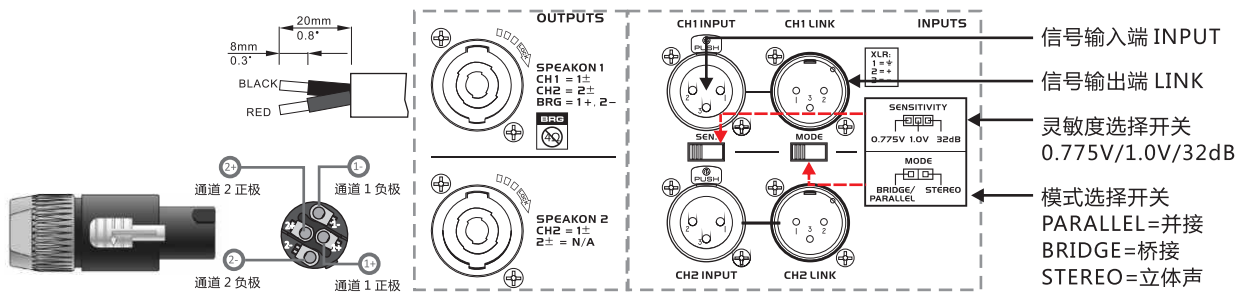

信号输入端 INPUT

信号输出端 LINK

灵敏度选择开关
0.775V/1.0V/32dB

模式选择开关
PARALLEL=并接
BRIDGE=桥接
STEREO=立体声

! 灵敏度选择应根据音频系统配置、使用场合、适用人群等要求，因选择不匹配可能导致产品损坏。

连接方式



输入 INPUT
平衡连接 公座 XLR

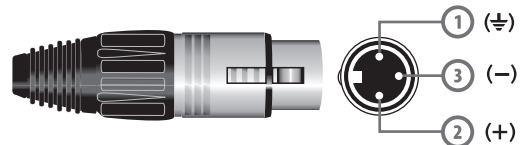

链接 LINK
平衡连接 母座 XLR

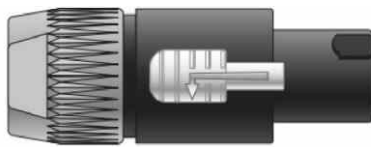

SPEAKON 功率输出 - 扬声器输出
NL4 Speakon 接线方式



产品正常工作范围
为4~16欧。



禁止桥接4欧，
桥接4欧会导致功放使用
寿命缩短或者产生
不必要的故障！



焊接质量很重要！
虚焊或是焊接错误，
将可能影响到正常使用，
甚至产生故障。

功率输出 2

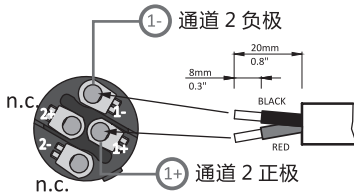

功率输出 1
桥接模式

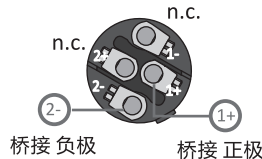

功率输出 1

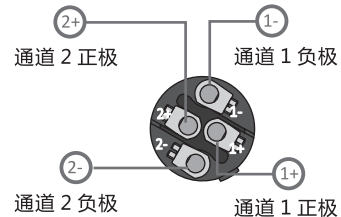

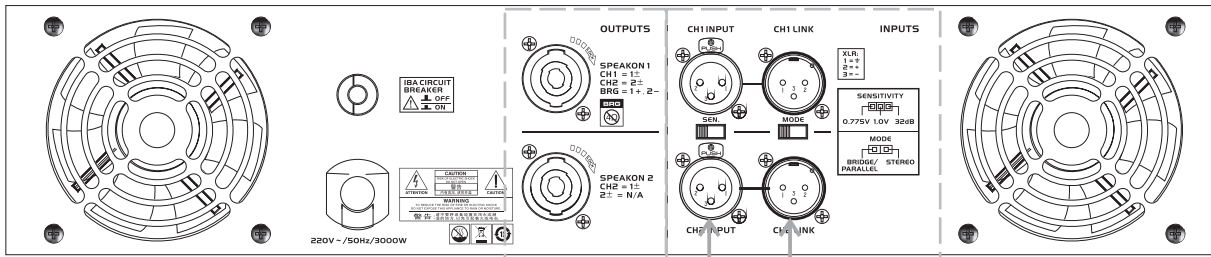

输入连接方式

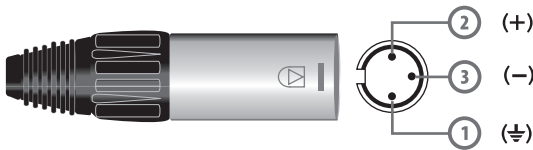

输入 INPUT
平衡连接 公座 XLR

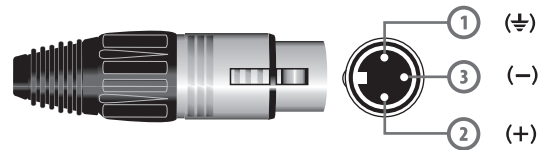

链接 LINK
平衡连接 母座 XLR

输出连接方式

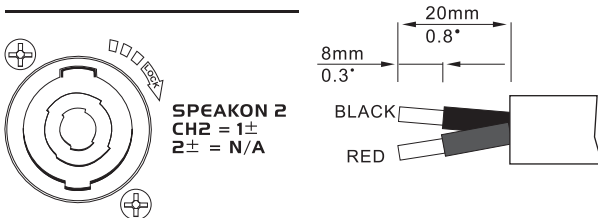

SPEAKON 2 CH2 = 1±, 2± = N/A

焊接质量很重要！
虚焊或是焊接错误，
将可能影响到正常使用，
甚至产生故障。

立体声模式

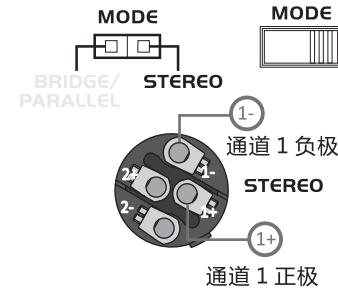

当前模式正常工作
范围为4~16欧。

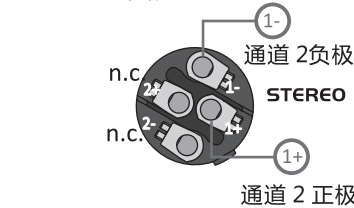

桥接模式

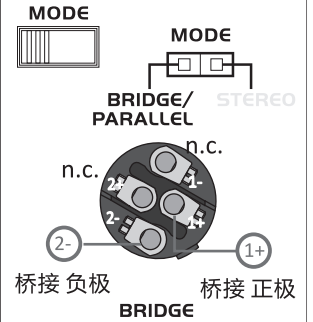

产品桥接工作
范围为4~16欧。

不建议长期桥接4欧，
长期4欧桥接会导致
功放使用寿命缩短
或者产生不必要的
故障！

并接模式



当前模式正常工作
范围为4~16欧。

型号 I-2x1200W

功率

8Ω立体声功率	1200Wx2
4Ω立体声功率	1800Wx2 *
8Ω桥接功率	3500W *

其它指标

频率响应	20Hz-20kHz, +0/-1dB
总谐波失真	<0.06%
信噪比(A Weighted)	≥98dB
阻尼系数	>200
输入灵敏度	0.775V/1.0V/32dB
输入阻抗(平衡/不平衡)	20kΩ/10kΩ
电压增益	42dB
输出类别	Class I
风路	从前到后抽风
保护功能	软启动/直流/短路/过载/过热保护/VHF/开机音量渐大

连接器

输入部分	平衡输入XLR母插座/平衡并接XLR公插座
输出部分	SPEAKON(音箱螺旋座)

使用功能

面板功能	电源开关/音量控制旋钮/电源指示/信号指示/削峰指示/保护指示
后板功能	立体声/桥并接模式选择开关/灵敏度选择开关

注意：1. *以上功率是使用40ms脉冲1kHz正弦波在1%总谐波失真下测量得出；
2. 其余功率是按EIA标准下测量得出。

尺寸和重量

产品外形尺寸(Wx Lx H) (mm)	483x452.5x89
外包装尺寸(Wx Lx H) (mm)	595x565x170
毛重	26.2kg
电源	16A电源线

通电后，无任何反应

马上用万用表测量插座是否有电，在没有万用表时可用试电笔，但必须灯泡显示明亮，否则可怀疑电压不正常。若插座电压正常，供电无怀疑后，通电的功放仍然无任何反应，则可判断该功放有故障，需要专业人员进行进一步故障判断。

功放无声音输出

1、首先判断输入的信号是否正确

▲卡侬XLR的2/3脚有无反接的可能，地屏蔽线是否连接可靠。跟据输入线路的设计不同，可能在以上有些产品会表现正常，而有些则无声，请必须按照2+、3-的方式连接。不可以采用比对其他功放（包括同厂产品）的方式判断。

2、面板指示信号灯不亮

排除信号线问题后，若功放无输入信号反映，可判断功放本身可能存在故障，需专业人员进行进一步故障判断。

3、输入信号正常但仍无声

正面的信号指示灯是否有闪动和根据音量大小而跳跃，若正常，而无声音输出，立即检查连接的NL4插头是否连接正确（±1，±2的连接问题）是否连接牢靠。若以上都无问题，仍然无声，可以尝试其它通道观察是否有相同的现象。若还是一样，请立即更换另一个NL4插头再作连接尝试。

▲跟据经验，可能有某些插头和该产品的插座接触不良导致的。

功放输出声音失真

1、失真表现为小声音已经很明显能听出声音有破裂声在排除信号本身和音箱的问题后，可判断为该功放可能存在故障。需专业人员进行进一步故障判断。

2、某个频段失真

首先判断音箱本身是否能承受该功放的输出功率，一般在95~105分贝时判断，再大的音量输出不作评论。本篇幅只讨论功放自身问题的排除。若是在中频段声音有轻微破裂尾音，并且在音量越小时表现为越明显，可判断为功放可能有交越失真，此失真声音比较容易和音箱本身高频激励器故障混淆，请做出判断前最好再连接其它判断为正常性能的音箱比较测试一下。

3、大声压时失真

在小声压时表现正常的情况下，首先判断音箱对所播放音乐信号的大动态时的承受能力。请在合适的音量下聆听判断，若功放削峰指示灯（CLIP）时常亮起，请再降低音量后判断。音箱和功放都有适用的范围，请在所能接受的范围内使用，在超大音量下失真则可能功放及音箱都已经进入饱和状况，请适当降低音量使用。

功放保护指示灯（PROT）点亮

此指示灯点亮表明功放进入保护状态。形势不妙！

1、可能是温度过高、有高于4K的连续正弦波输出超过1秒、输出短路或接近短路等。以上情况可恢复的。并非故障。等恢复后可继续使用。但过热会等待较长时间才可恢复。并且出现过热时就必须检查产品的风扇是否运作正常，空间温度是否过高等，须排除问题后方可继续运作。若怀疑音箱短路，可以用万用表测量音箱线两端直流电阻是否低于2欧甚至1欧。（因电阻较小，为保证测试精度，请校准万用表后再测量）

2、此灯常亮，不可恢复

此类情况一般为功放本身故障导致，请联系维修人员跟进。

有交流声（哼声或称之为电流声）

1、功放不插入任何信号就有交流声

请将功放搬离于系统电源地线隔离的位置继续测试，只连接火零N/L，不接地线。若输出还是有交流声，可判断为产品本身有问题，请与维修人员联系。

2、连接系统后有交流声

此现象为系统各单元设备的地电位不同而产生的。多数出现在供电为三相电时，各设备连接不同的相线，甚至不同上庄电源，零线带电导致，并非功放故障。

解决办法超出本说明书叙述范围，这里附赠解决经验，仅供参考，本厂不对此叙述负责！

A、梳理用电，尽可能使用同一配电箱的电源。

B、在必须接地的情况下，将不同的接地点强迫接为一点，在此动作前，请判断地线电位必须为零，若地线本身带电，则表明地线可能与零线相连。请先解决此问题。

C、我们不建议浮地使用设备。

以下情况表示放大器需要维修

- 1.产品冒烟或者发出严重烧焦味而不能使用时
- 2.机箱严重凹陷或者变形
- 3.产品浸入液体中
- 4.内部部件松动
- 5.加电时交流断路器自动跳开或保险管熔断

免责声明

蜚声演出器材制造有限公司对于因不当使用本产品而导致扬声器或其它设备损坏不承担任何责任！蜚声演出器材制造有限公司对本产品提供2年有限质量保证。蜚声演出器材制造有限公司保证其产品自销售之日起2年内不会发生材料和制造工艺缺陷；若在正常安装和使用条件下发生的损坏，蜚声演出器材制造有限公司将按照质保协议无偿更换有缺陷的零件和维修故障产品。但客户必须将产品送回我们的工厂或授权的维修点或指定经销商处，同时必须预付运费和附带购买证明（产品保修卡客户联及销售收据或发票复印件）。

此质保协议规定，退回的产品必须经过我们检查判断存在质量缺陷。本质保不适用于任何误用、疏忽、意外、不正确安装而导致损坏的产品或日期编码、序列号被去掉或破损致不能辨认的产品。蜚声演出器材制造有限公司不对意外或间接发生的损害承担责任。此质保赋予您特定的法律权利。

通讯地址：

蜚声演出器材制造有限公司售后服务部
 中华人民共和国，广东省，佛山市，南海区，和顺，文教路东段39号，蜚声工业园。

邮政编码：
528241

电话：
0757-8560-8331

传真：
0757-8568-8191

电子邮件：
support@saechina.com

制造商网址：
www.saeaudio.com

产品物质拆分表

为满足中国《电子信息产品污染控制管理办法》（信息产业部第39号令）的相关规定和要求，现对产品中有害物质，按部件分类，声明如下：

部件名称	有毒有害物质或元素					
	铅 (Pb)	汞 (Hg)	镉 (Cd)	六价铬 (Cr(VI))	多溴联苯 (PBB)	多溴二苯醚 (PBED)
机箱	×	○	○	○	○	○
主板模块	×	○	○	○	×	×
电源模块	×	○	○	○	×	×
I/O板模块	×	○	○	○	×	×
控制模块	×	○	○	○	×	×
灯板	×	○	○	○	×	×
备注： ○：表示该有害物质在该部件所有均质材料中的含量均在SJ/T11363-2006规定的限量要求下 ×：表示该有害物质至少在该部件的某一均质材料中的含量超出SJ/T11363-2006规定的限量要求。						

在中华人民共和国境内销售的电子信息产品上将贴上有“环保使用期限”（EPuP）符号。











圆圈中的数字代表产品的正常环保使用年限。

Important Safety Notice

1. Read the rules, pay attention to all warnings, and comply with these rules.
2. It is forbidden to spray liquid around the product. Please do not placed the liquid container above the product, such as vases, etc. The dry cloth and air pressure gun can be used for cleaning.
3. Be careful not to form a hot air circulation. Please install as the recommended way.
4. Do not install the product near the heat source, and try to keep the environment temperature below 35°C.
5. ⊕ Ground protection, when connect to power supply, corresponding ground protection measurements should be taken.
6. Please protect the power cord from treading and squeezing, especially the plug, power socket and connected devices.
Warning: Power plug/Equipment coupler, as a circuit cutting off device, should be kept available at any time.
7. Must be in accordance with the following sequence switch to use the product: Turn on: Pre-Amp ~ Amplifier;
Turn off: Amplifier ~ Pre-Amp.
8. Before power on, must ensure that the power supply voltage in accordance with the requirement of the product.
9. If input signal parallel with more than three power amplifiers, it is suggested to use signal distributor to make sure no distortion of the input signal.
10. Do not connect an output port of one channel into an input port of the other channel in the same amplifier. Do not connect an output port into an output port of another amplifier in series or parallel.
11. When configure an amplifier into a system, the output power of amplifier should be 50%-100% higher than the nominal power which is the same impedance with the loudspeaker. And be careful to use the bridge mode.
12. It is forbidden to connect an oscilloscope probe into an amplifier output interface in state of bridge when the amplifier is being maintained, to avoid amplifier or oscilloscope got broken.
13. Suggest: 1) Please use qualified NL4 SPEAKON connectors.
2) Please make the appropriate power distribution when more than one amplifier working at the same time, to achieve qualified using environment.

Safety instructions

 <p>When stacking non-horizontally, the air outlet should be upward or be straight to the vent.</p>	 <p>This product is suitable for safe use below altitudes 2000m.(Only for our company Switching Mode Power Supply equipments)</p>
 <p>Input/output connection cables can not be stacked on the air outlet of the product. They should be tied up on both sides of the amplifier.</p>	 <p>This product is suitable for safe use of non tropical climate conditions.</p>
 <p>The ambient temperature should be lower than 35°C while running the amplifier</p>	 <p>The materials which need to be technically recycled and can not be placed in the trash can.</p>
 <p>Please verify the temperature in the cabinet when the project is debugged, and should be kept below 35°C even though in the extreme conditions.</p>	 <p>The lightning bolt triangle is used to alert the user To the risk of electric shock. Non-professional Qualified technicians do not open top or bottom covers for maintenance</p>



WARNING: To reduce the risk of fire or electric Shock, do not expose this apparatus To rain or moisture.

Welcome

Thank you very much for purchasing the products of Famous Performance Equipment Manufacturing Co., LTD. This product has built-in HD+HR technology, with high analytical power, large dynamic performance, Sound transparent and smooth, dense and powerful, full of granular sense, dynamic energy, Make the overall tone more dense, more smooth, easy to sing, and Can give a large dynamic, leading a new generation of KTV sound trend!

Unpacking

Please unpack and inspect your amplifier for any damage that may have occurred during transit. Confirm the preset voltage of the power amplifier matches your local voltage rating (Please refer to the print on the rear panel for detailed information). We also recommend that you save all packing materials so you will have them when need to return the power amplifier.

Support and Service

Please contact directly with the local SAE distributor, to get the quickest after-sale service and technical support. When need to contact with manufacturer, email and fax are available:
 Email: support@saechina.com
 FAX: +86-757-8568-8191

Important safety precautions

Our products has already taken the safe requirement in to consideration and all the finished products have been tested under the requirement of the government before sale. Due to the inner dangerous high voltage and electricity, we strongly recommend you read all instructions, warnings and cautions contained in this manual. It will increase the chance of getting shock by the electricity if the product falls down, recess in the appearance, soaked or there were some parts loose internal. If there are problems above, please turn off power immediately and send the defective units to local distributor for service.

Power & Wiring distribution

Referring to the power dissipation and power supply/AC of different product for wiring We suggest the users to match not less than the following wiring size specifications, to obtain the better comprehensive properties.

The Standard Voltage : 220 ~

Model	Dissipation Power	Cable size
I-2x1200W	3000W	≥2.5mm ²

Front Panel

Indicator light description

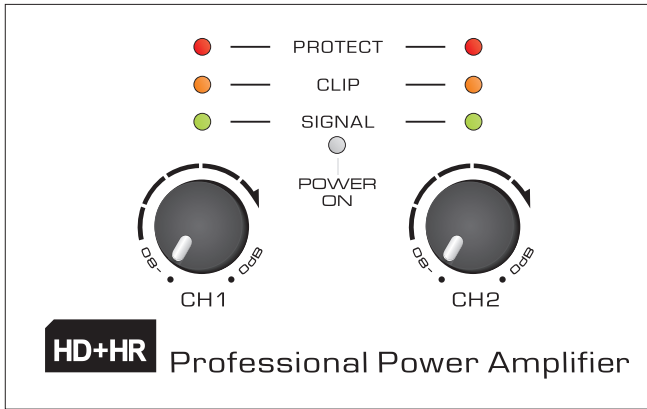

- PROTECT → Illuminates when either protection circuit action.
- CLIP → Illuminates when limiter is protecting the amplifier from input overload.
- SIGNAL → Illuminates when output signal around +6dB(2V) than full power.
- POWER ON → Illuminates when the amplifier start.
- CH1-CH2 → Gain Controller Knob 300° volume knob from 0 to -80dB.
Stereo/Paralle Mode: volumes of CH1 and CH2 control independently.

Cleaning guide of the dust filter



The first time cleaning of the strainer mesh should be right after installation. Recommend to clean the strainer mesh quarterly.

Please do not run the product without the dust filter, or it makes the service life of the product shorten.

Such condition will be considered as no warranty.

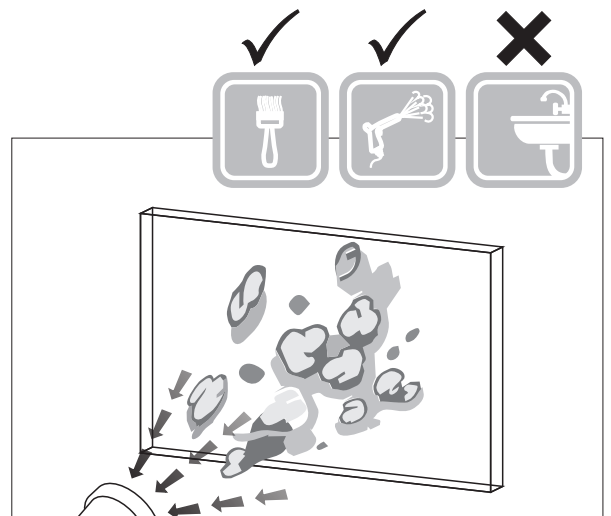

Rear Panel

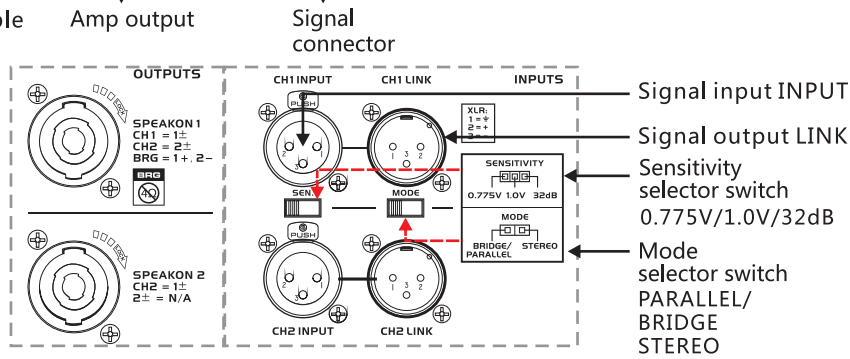
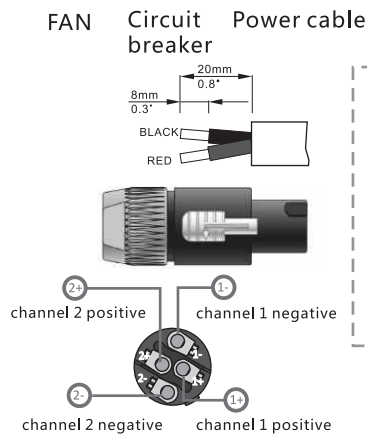
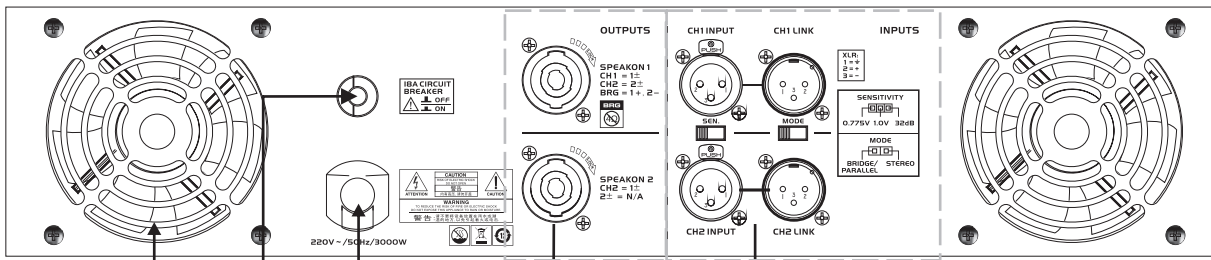

! Sensitivity selection should be based on audio system configuration, use occasions, Applicable to people and other requirements, due to the selection of mismatched may lead to product damage.

Connector:

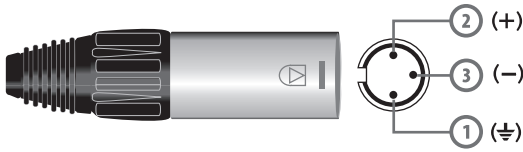

INPUT
Balanced connection male XLR

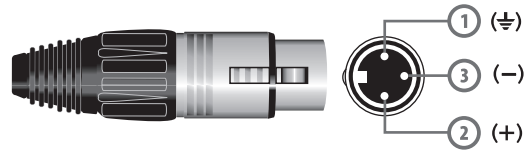

LINK
Balanced connection base XLR

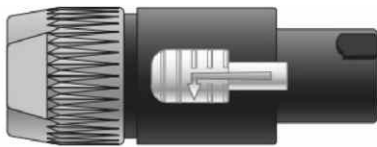

Speakon power output - speaker output
NL4 SPEAKON connection mode



It can work from 4-16Ω in stereo or parallel mode.



We don't suggest you use the amplifier under 4ohm bridge mode for a long time, it will short its normal use life or have some unnecessary failure.



The quality of your soldering is very important. Virtual welding or soldering errors, would be likely to affect the normal use or even failure.

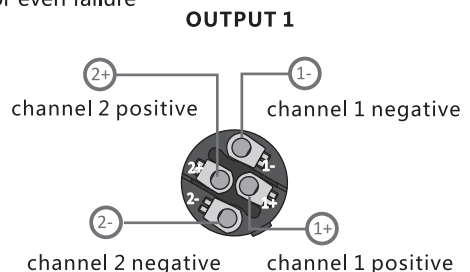
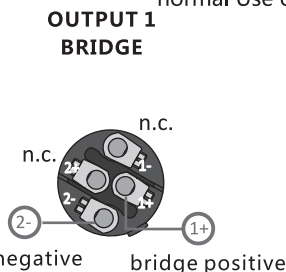
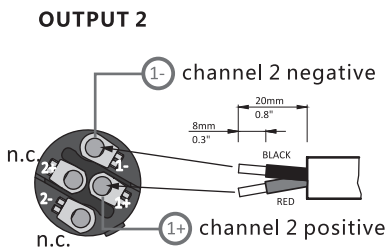

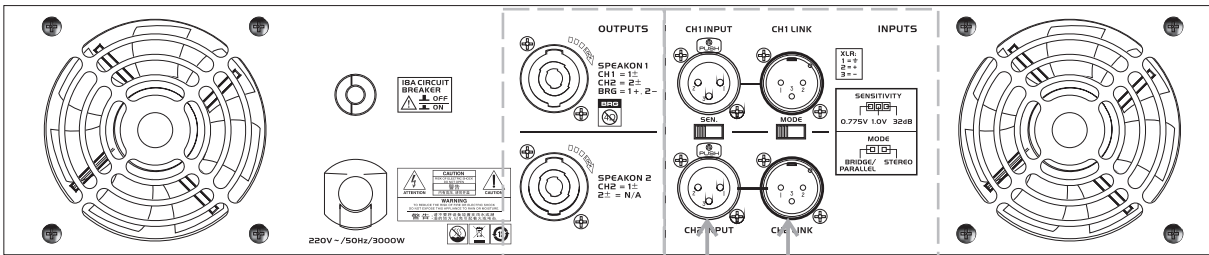

Connector:

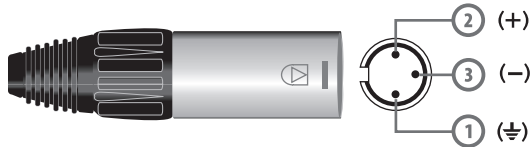

INPUT
Balanced connection male XLR

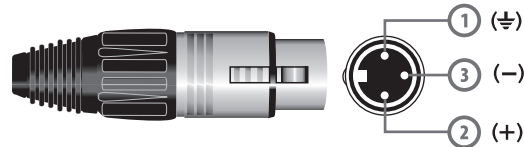

LINK
Balanced connection base XLR

Output connector:

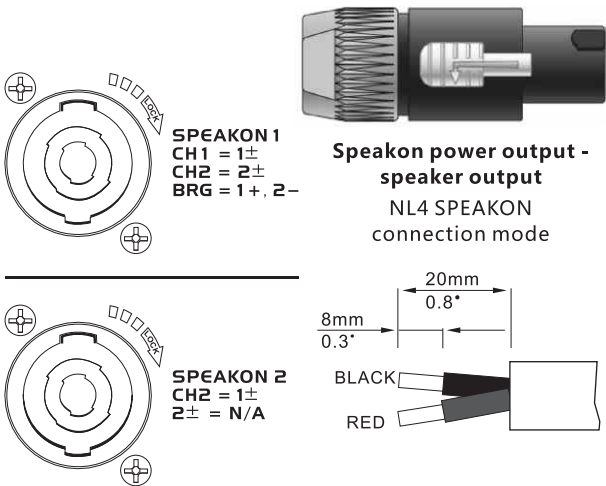

! The quality of your soldering is very important. Virtual welding or soldering errors, would be likely to affect the normal use or even failure.

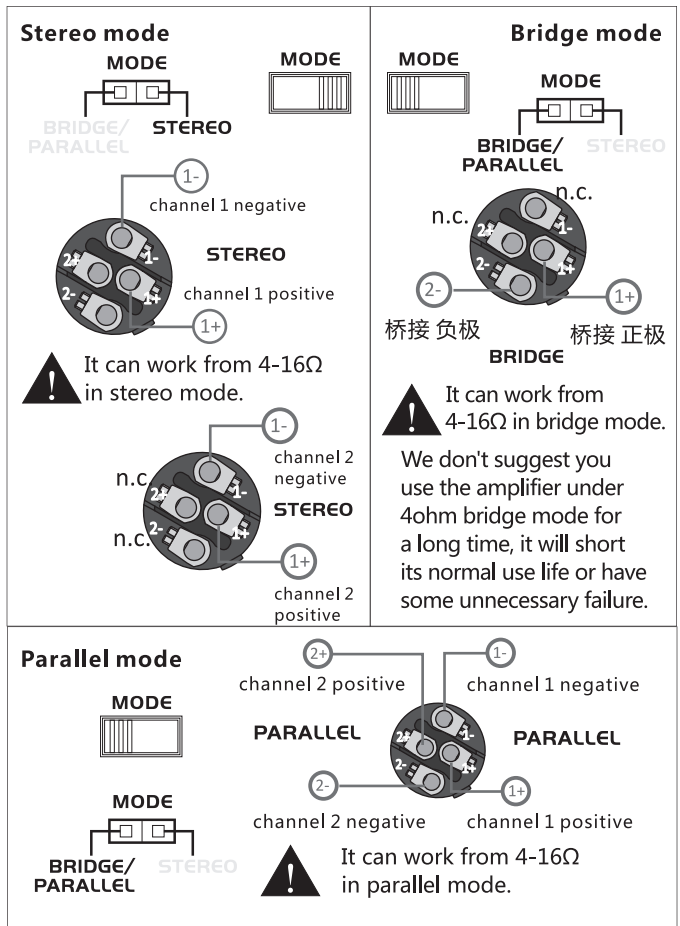

Model I-2x1200W

Output power

8Ω stereo	1200Wx2
4Ω stereo	1800Wx2 *
8Ω bridge	3500W *

Other Specifications

Frequency response	20Hz-20kHz , +0/-1dB
THD+N	<0.06%
S/N rate	≥98dB
Damping factor	>200
Input sensitivity	0.775V/1.0V/32dB
Input impedance(bal/unbal)	20kΩ/10kΩ
Voltage gain (8 ohm)	42dB
Output circuitry	Class I
Cooling	Air flow from front to rear
Protection	Soft start, VHF, DC, short circuit, over load, clip, over heat, progressive volume

Connection

Input	Balance input XLR-F, Balance output XLR-M
Output	NL4 SPEAKON

Function

Front panel	Working indicator, Signal/Clip/Protection/Power on volume control knob
Rear panel	Sensitivity selection switch、 stereo/parallel/bridge switch

Remark : 1、*,The power is tested under the condition of 40ms burst,1kHz sine wave and 1% THD
 2、The other power is tested under EIA standard.

Dimensions/Weight

Product Dimension(mm)	483x452.5x89
Packaging Dimension(mm)	595x565x170
G.W.	26.2kg
Power Supply	16A power cord

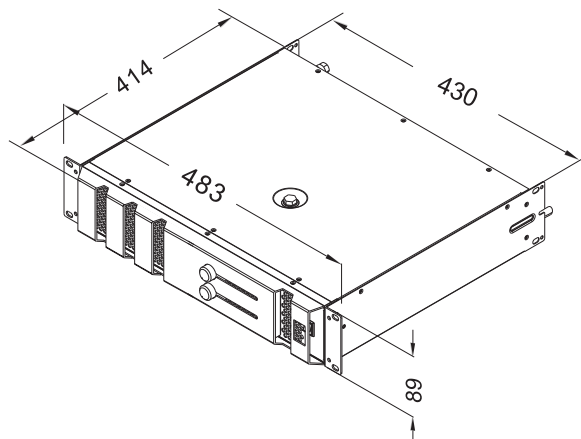

After powered without any response

Measure the outlet with a multimeter to check if there is power available and when no multimeter, you can have a test pencil. If the power supply is normal and the amplifier still no response when powered then there is something wrong with the amplifier, need professional person to check it.

No signal output

1. First check if the signal input is right.

⚠️ Check the connect of XLR, if the 2 and 3 reverted or the ground is reliable. Different circuitry design will have different connect way of the XLR, please follow the 2+, 3- to soldering.

It can not be judged by comparing with other amplifiers (including other amplifiers in the same factory).

2. The signal light don't lights up

If all the signal input is fine and the signal light don't lights up then may the amplifier has failure, you need to ask the professional person to check it.

3. Signal input normal but no sound

The signal light will flash with the change of input Volume, but now sound out, then you can check the connect of speakon if it is connect good and the wires are connect right (some times the problem of the wires connect, check its ± 1 and ± 2 connect), after the check above if still no sound out, please change a speaker cable and check again. Because some times also caused by the bad quality of the Speakon connector problem of the amplifier.

⚠️ Through experiences, it may caused by the bad connection of some plugs and the socket.

Output sound distortion

1. After check the signal and loudspeaker they are fine and still can hear distortion when small sound, then may the amplifier has failure, need professional person to check it.

2. Some frequency band has distortion

First, check if the loudspeaker already overload, normally judge it in 95~105dB for higher SPL we don't comment here. Here we just think about the failure recovery of the amplifier. If in the middle have some rupture sound and more smaller volume more obvious, then it should be crossover distortion of the amplifier and this kind of distortion is easy to confuse with the failure of loudspeaker itself. If the amplifier have problem then you should send back to the manufacture for repair.

3. Distortion is High SPL

If the sound is normal when small volume and then you need to check the limit SPL of the loudspeaker. You can listen it in suitable volume and if clip light works, then you need reduce the output. Both loudspeaker and amplifier have limit, you should use them in their limit if in very high SPL they have distortion you should take care of them and reduce the output to the right position.

The protection light blinks

When the PROT light works, the amplifier into the protection mode.

1. Maybe the temperature is too high or output short or near short and they are not failure they can recovery after you can use it normally. But over heat will take more time to recovery. Also when over heat happened you should check the fan and the temperature of the install environment, if does you should solve the problem then can use amplifier. If you think the speaker was short, you can with a multimeter to check if the resist is lower than 2 ohm or 1 ohm with DC (Please calibrate the multimeter to measure for accuracy because of the small resistance).

2. If the PROT light always light up then it should be the problem of amplifier, you should send it back to professional person for repair.

Hum in the system

1. Hum exists even when there is no signal

Please keep the amplifier away from earth wire of power supply cables, just connect the fire wire and zero wire, no ground wire. If the hum is still existing, it can be judged that there are some problems in the amplifier. Please get in touch with professionals.

2. Hum exists when the system is completely connected
This is caused by the different ground voltages in difference devices in the system, mainly happens when the power supply is under three-phase distribution condition, each device is connected to different phase. This is not caused by amplifier.

Solution experiences, just for reference

- A. Combing the electricity, the power distribution box using the same one for all if possible.
- B. Make sure the grounding wire potential is zero and force the different grounding wire to the same level, if the grounding wire itself charged, indicates that the wire may be connected with the zero line. Please solve this problem.
- C. If unavailable above, then only to disconnect the ground wires of all devices, which helps to reduce the AC. But this is not meet the safe use of electricity, users must know what will happen if to do in this way. We do not recommend the floating use.

The amplifier is required maintenance in the condition below:

- 1. If the amplifier smokes or smells burning.
- 2. If the cabinet has severe indentation and deformation
- 3. If the amplifier are dipped into the water
- 4. If the internal components loosen
- 5. If AC breaker skips out when current increases.

Disclaimer

SAE Audio Co., Ltd. is not responsible for any damage of loudspeakers or other equipments caused by negligence or improper installation.

SAE Audio Co., Ltd. offers 2 years limited warranty for this product.

SAE Audio Co., Ltd. Guarantees that this product has no material defect during two years from the sales date; if the damage caused under the normal installation and operation, SAE Audio Co., Ltd. shall change the defective component and repair faulty product for free according to this Quality Guarantee Agreement. However, users must send the product to our factory or any authorized maintenance points or designated distributors, affording the re-paid freight, together with buying proof (including customer copy of product warranty card and payment receipt or invoice copy).

As per this Quality Guarantee Agreement, the returned product must be judged having manufacturing defect it self after our inspection. This agreement doesn't apply for products with damage caused by any wrong operation negligence, accident, inappropriate installation or products with no date code and sequence no or damaged ones beyond recognition.

SAE Audio Co., Ltd. shall not afford responsibility for any damage caused by accident or indirect factors. The agreement authorized you specific legal rights.

Address:

SAE Audio Co., Ltd. After Sale Department

No.39,East,Wenjiao Road,Heshun,Lishui,Nanhai,Foshan,Guangdong,China.

PC:

528241

Tel:

0757-8560-8331

Fax:

0757-8568-8191

Email:

support@saechina.com

Website:

www.saeaudio.com

Manufacturer:Sae Audio Co.,LTD.
Sae reserves the right to make changes in specifications
and products without prior notice.
制造商：蜚声演出器材制造有限公司
蜚声演出器材制造有限公司版权所有